



FOREVER REDWOOD

From the Forest, For the Forest since 1995

866.332.2403 (TOLL FREE); 7am – 7pm Pacific Time, Monday-Saturday

ASSEMBLY INSTRUCTIONS FOR THE **TODDLER WOODEN RECTANGULAR PICNIC TABLE**







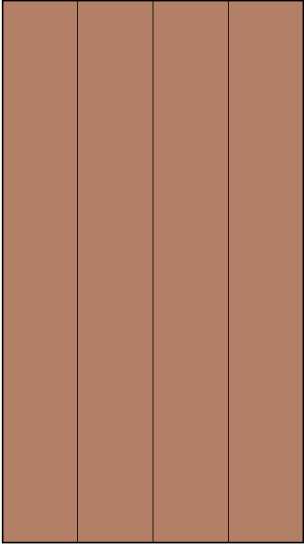
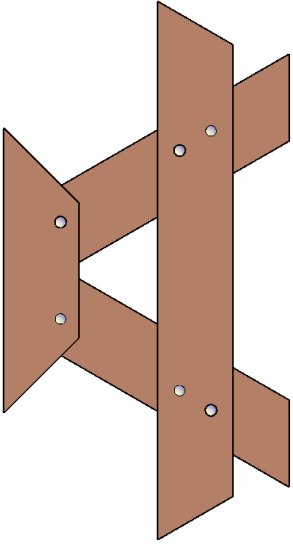
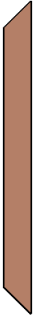
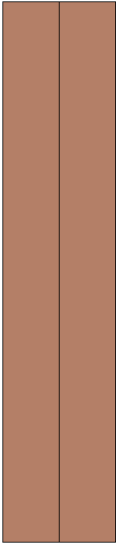

CONTENT OF BOXES

| Qty. | Description | Drawing | No. |
|------|-------------|--|-----|
| 1 | Tabletop |  | 1 |
| 2 | Legs |  | 2 |
| 2 | Knee Braces |  | 3 |
| 2 | Benches |  | 4 |

Note: Part numbers in the Content of Boxes Table are for reference only. These do not match to the numbers marked on the parts sent.

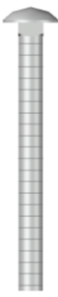

HARDWARE LIST

| Description | Drawing | No. |
|--|---|-----|
| 5/16" X 3 1/2" Bolts (To attach the legs to the tabletop. / To attach the benches to the legs). |  | A |
| 5/16" Washers |  | B |
| 5/16" Nuts |  | C |
| 8" X 3" Deck Screws (To attach the knee braces to the legs and to the tabletop). |  | D |

Note: Dimensions of your hardware will vary depending on size.



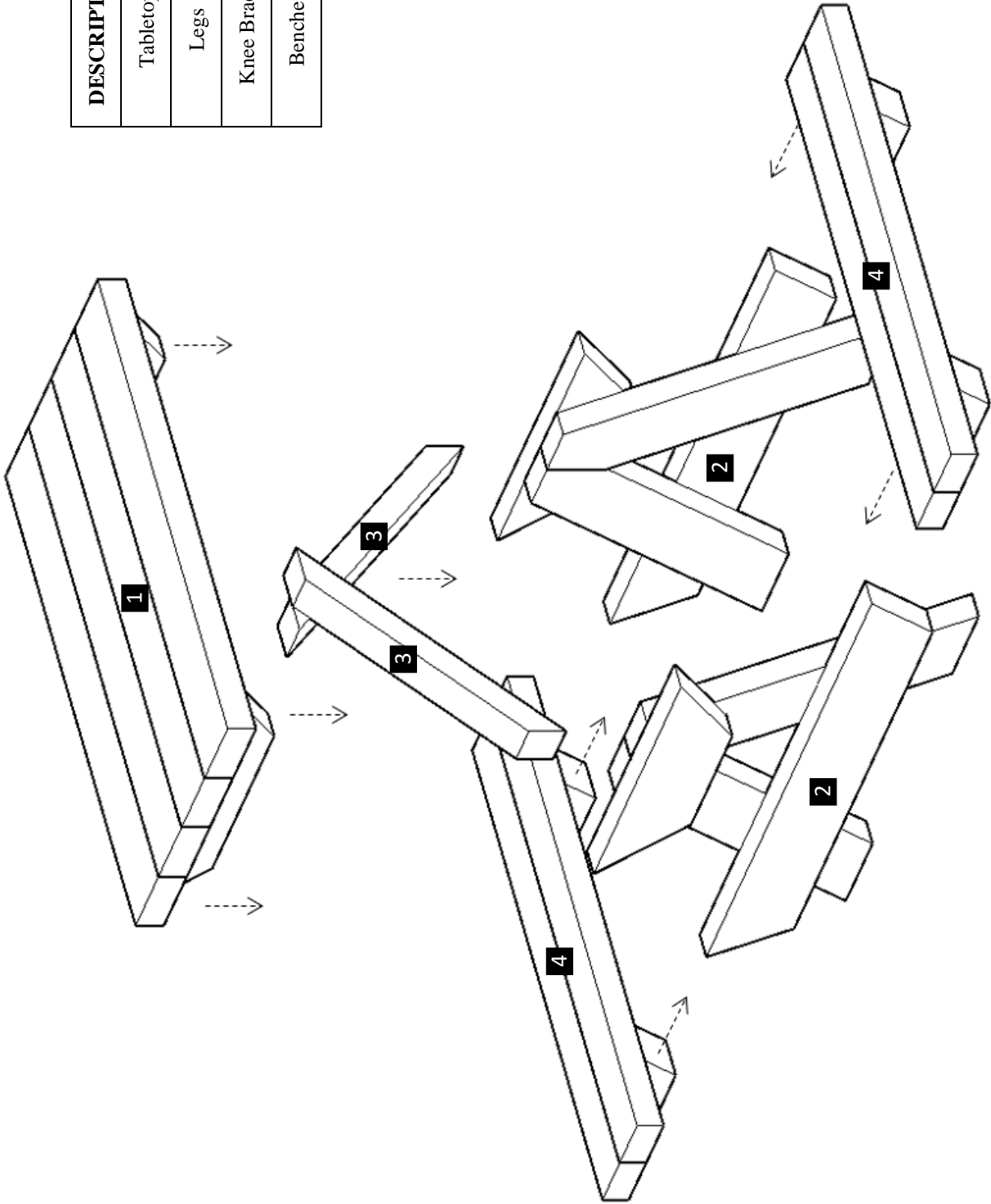

| DESCRIPTION | No |
|-------------|----|
| Tabletop | 1 |
| Legs | 2 |
| Knee Braces | 3 |
| Benches | 4 |

Note: Part numbers in the Drawing are for reference only. These do not match to the numbers marked on the parts sent.

Step 1: Place the tabletop (1) upside down. After that, use 5/16" x 3 1/2" bolts (A), washers (B) & nuts (C) to attach the legs (2) to the tabletop. Each part has a series of numbers that indicate where to attach the part with the corresponding number.

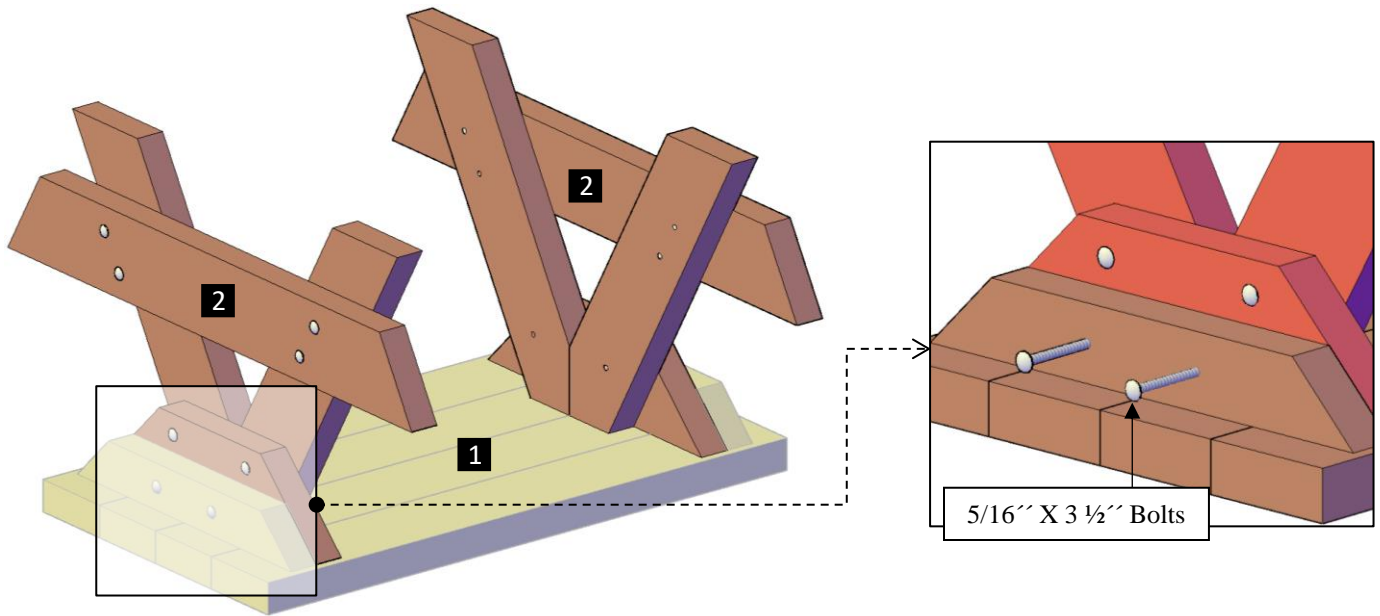

Step 2: Attach the knee braces (3) to the tabletop and to the legs with 3" deck screws (D). Each part has a series of numbers that indicate where to attach the part with the corresponding number.

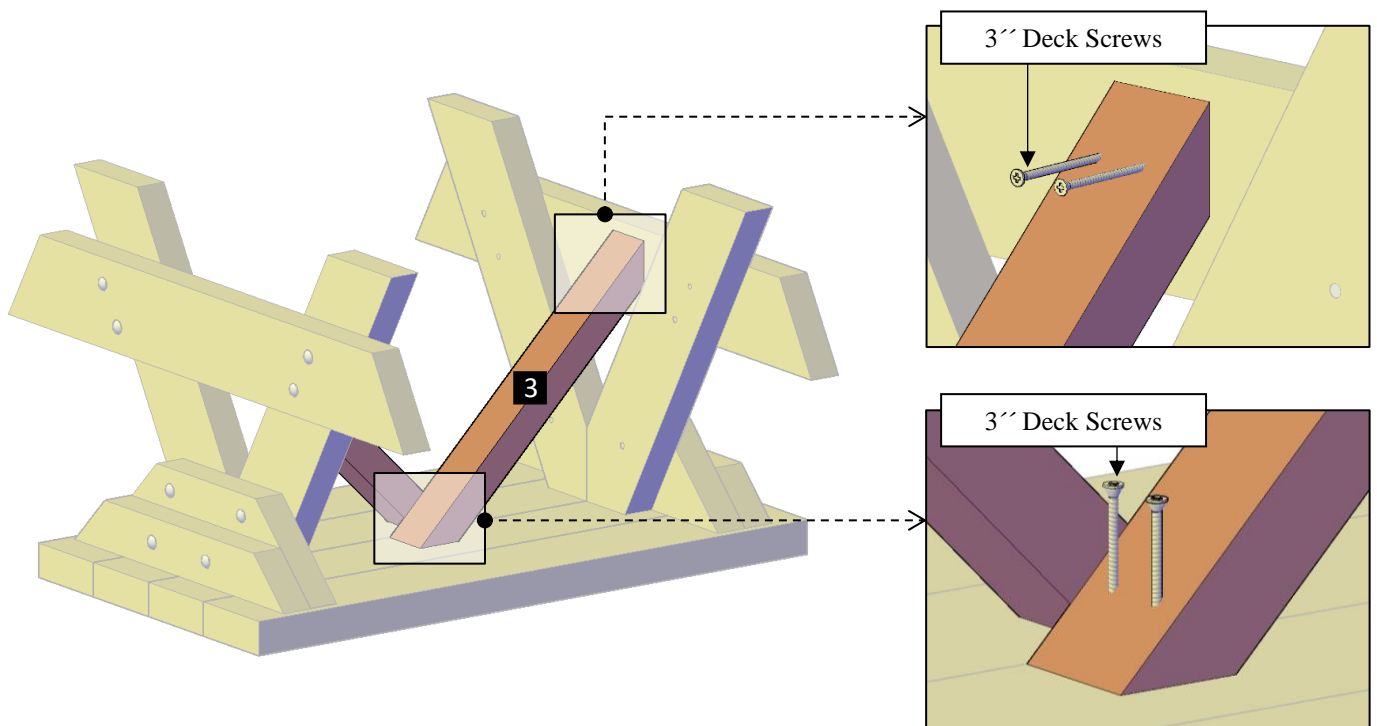

Step 3: Turn the table over its feet.

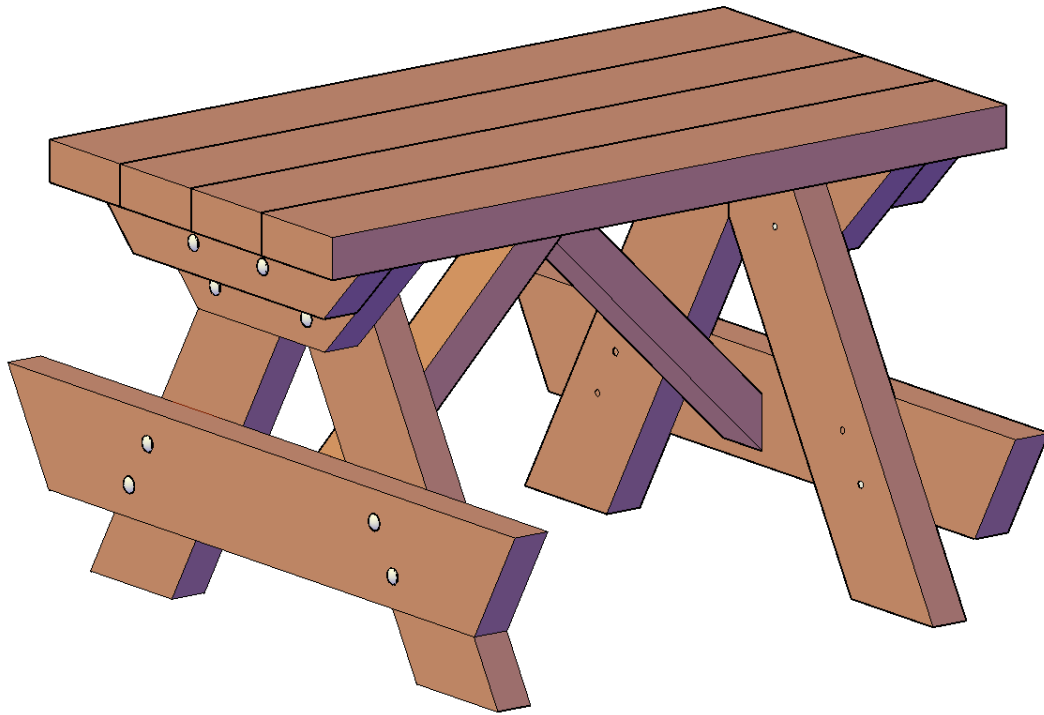

Step 4: Finally, use 5/16" x 3 1/2" bolts (A), washers (B) & nuts (C) to attach the benches (4) to the legs. Each part has a series of numbers that indicate where to attach the part with the corresponding number.

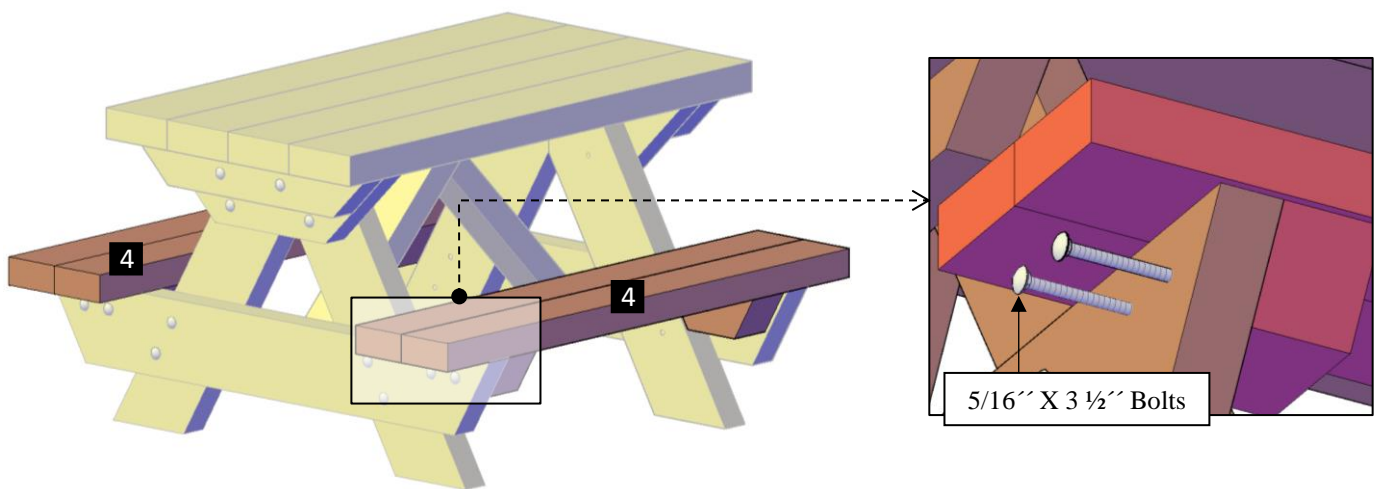



This completes the Picnic Table assembly. Hope you enjoy your set for many decades. If you ever have a problem or a question, don't hesitate to call us (866 332 2403) or email us. We are here to support you.