

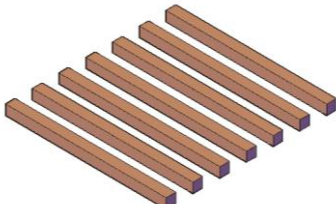





866.332.2403; Outside the US: 619.600.5630 8am-5pm Pacific Time, Monday-Friday

Assembly instructions for: **GARAGE ARBOR KIT**



CONTENT OF BOXES

Quantity	Description	Drawing
Will depend of Arbor length	Slats	
6	Supports	
2	Rafters	
2	Diagonal Supports	
5	Ledger Boards	
1	Middle Support	
3	6 1/2" x 3/8" Bolts	
20	Bolts to attach ledger board depends on type of wall	
Will depend of Arbor length	Deck Screws	

ASSEMBLY INSTRUCTIONS

The parts that go together have the same numbers written next to the predrilled holes they attach to. Align the parts with the numbers as shown for ease of reference

Tools required: ½-inch ratchet, a mallet or small hammer and drill.

Step 1: Attach 3 horizontal & 2 vertical ledger boards to wall with 4 bolts each as shown. We use bolts on wood walls and anchor bolts on concrete walls.

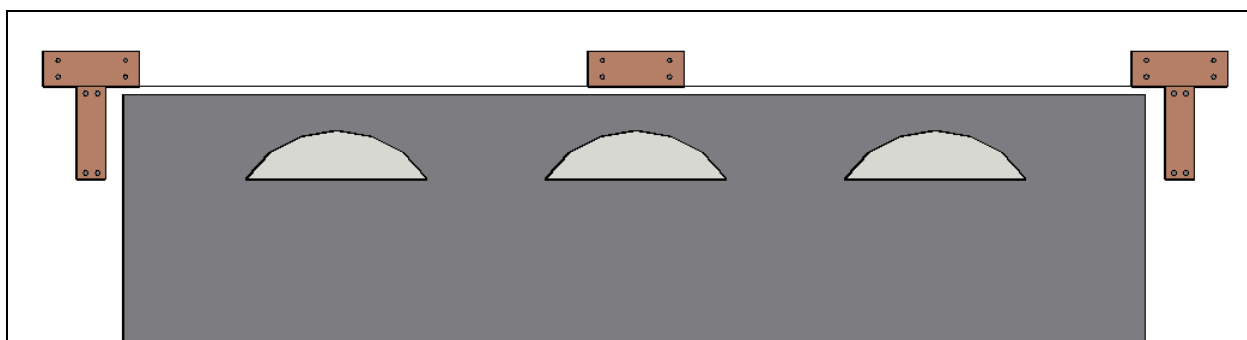

Step 2: Attach diagonal support to 2 supports with one bolt (6 ½" x 3/8"), washer & nut.

Sit the supports atop the horizontal ledger board and attach them with screws. Repeat this step for the other diagonal support.

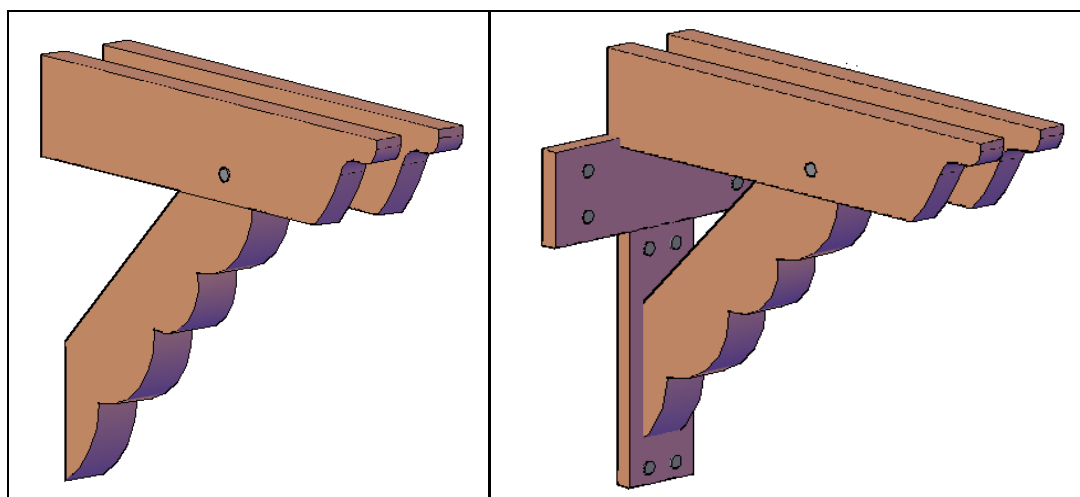

Step 3: Attach the middle support to 2 supports as shown with one bolt (6 ½" x 3/8"), washer & nut. Sit the supports atop the horizontal ledger board and attach them with screws. The ledger board is usually a 2" x 6" that is lag bolted into the framing of the house and sits on the siding.

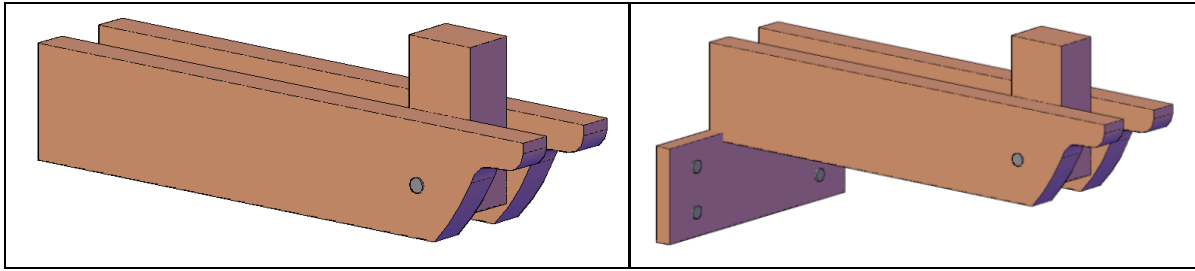

Step 4: Attach rafters to supports with deck screws (3" x #8", four each rafter) at 45 degree angles. Make sure each rafter's notches are snugly into the supports before adding the deck screws. Since the arbor was already assembled in the shop, the deck screw holes are already in each rafter. Reuse the existing hole to reattach. The supports have lines marking the exact spot to attach the rafters. The rafters do not have numbers. They are all cut identically and are interchangeable. Just make sure to stay to the markings on the supports to keep the spacing exactly the same.

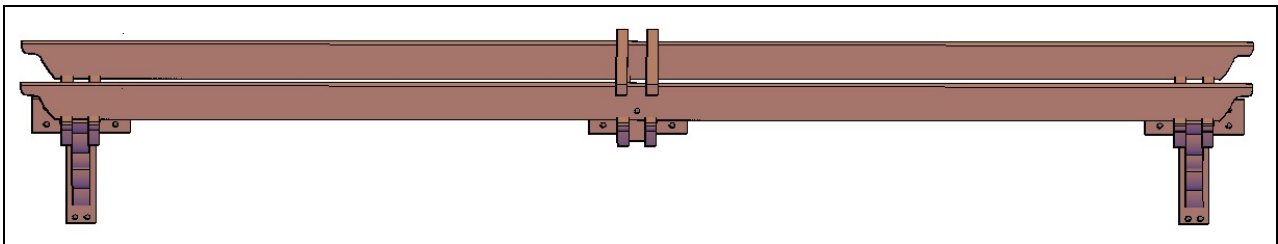
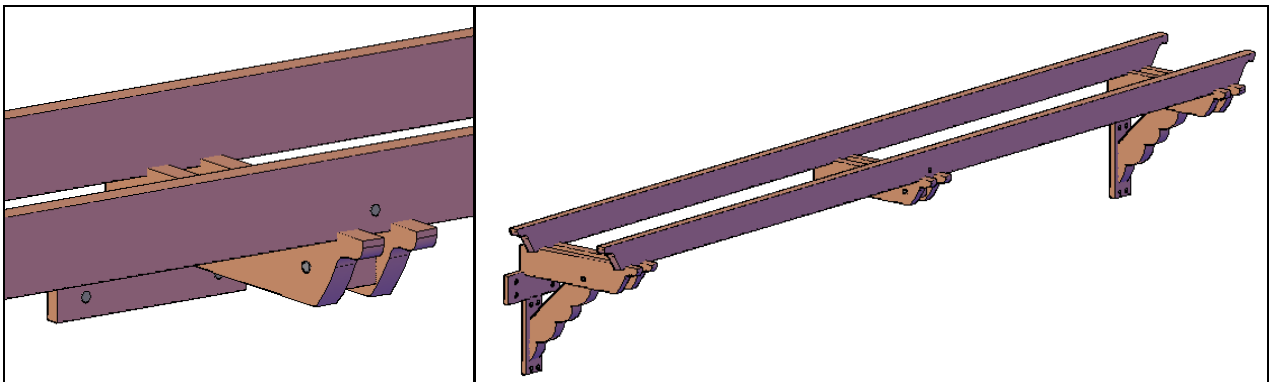

Step 5: Attach slats to rafters with deck screws (3" x 8", eight for each slat, one for rafter). The slats are all notched identically.

