

Assembly instructions for: **360 GAZEBOS**

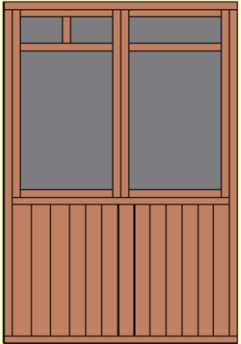
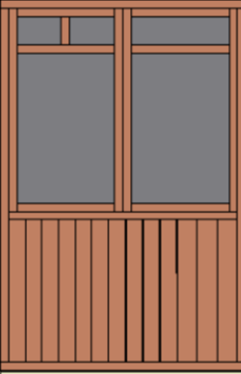
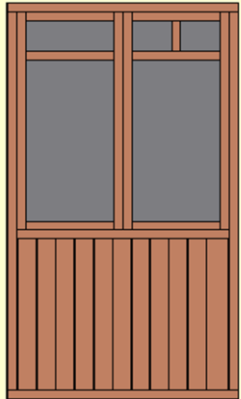
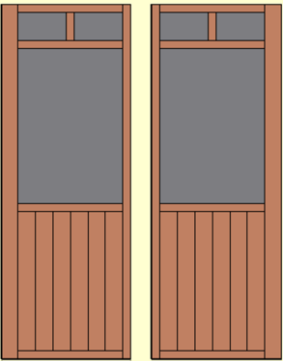
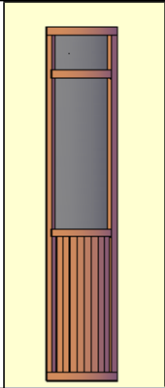
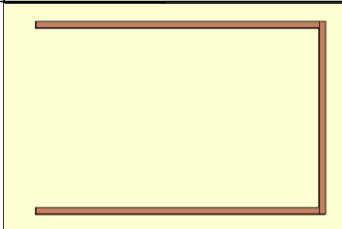
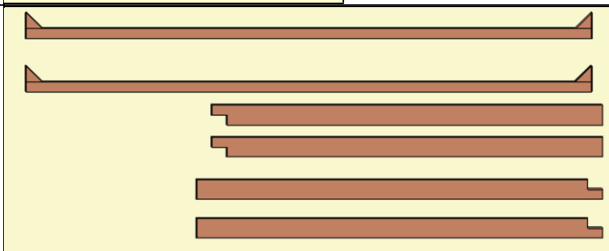
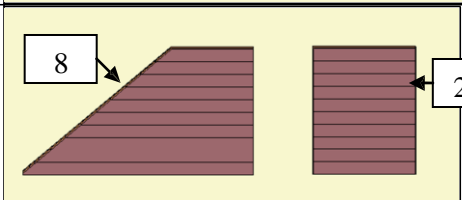
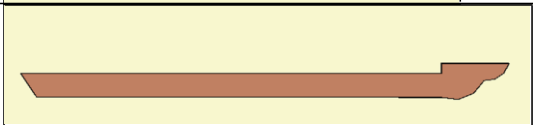
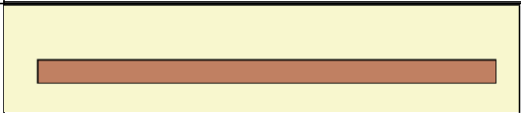
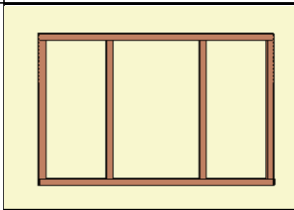
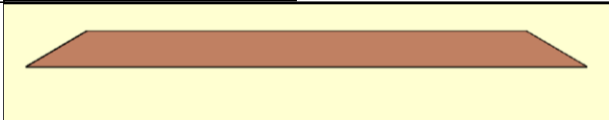

Quantity	Description	Drawing	
Quantity will vary depending on size	Front wall panels – panels		
Quantity will vary depending on size	Rear wall window		
Quantity will vary depending on size	Left side & right side		
2	Doors		

4	Angled Corner Panels	
1	Door frame	
6	Roof timbers	
10	Roof panels	
10	Rafters	
10	Roof trim	
1	Skylight	
Quantity will vary depending on size	Snow Load boards	

Quantity	Description
6	Bolts 4" x 5/16", washers & nuts
10	Bolts 6 1/2" x 3/8", washers & nuts
4	Bolts 3 1/2" x 5/16", washers & nuts
8	Bolts 4 1/2" x 5/16", washers & nuts
4	Bolts 8" x 3/8", washers & nuts
100	Screws 3"x 8" SS

The parts that go together have the same numbers written next to the predrilled holes they attach to. Align the parts with the numbers as shown for ease of reference.



Step 1:

Attach corner panel to wall panel with six deckscrews (3"X 8"). (Match up the numbers to attach the two parts together).

When you finish the walls of the Gazebo should be as shown.

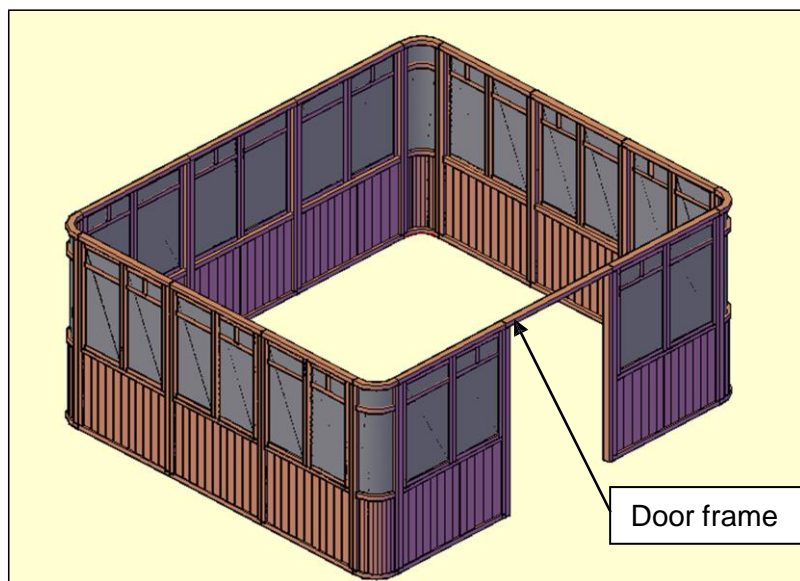

Step 2:

Attach the timbers together to form the base of the roof with 4 bolts (3 1/2"x 5/16") washers & nuts. (Match up the numbers to attach the two parts together). Tap the bolt all the way into the wood to set it. Then add a washer and nut and lightly tighten.

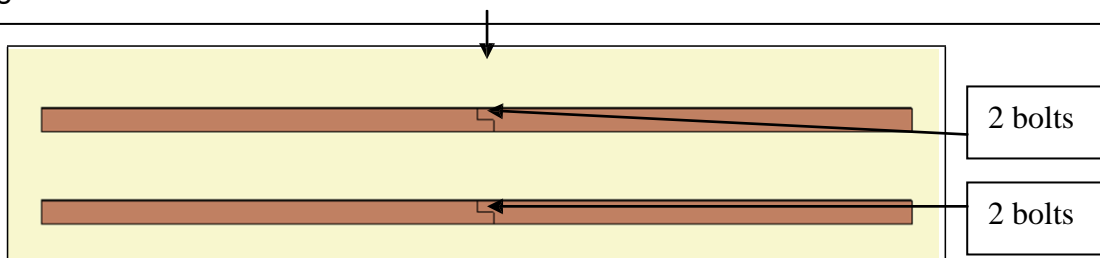

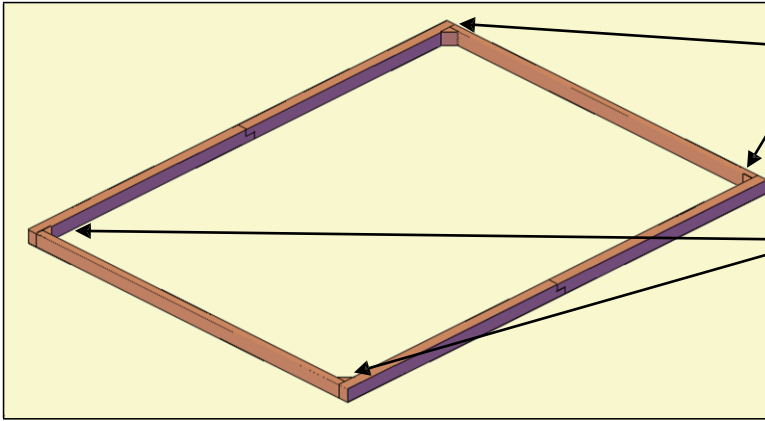

Step 3:

Attach the rest of the base of the roof with 8 bolts (4 1/2"x 5/16") washers & nuts. Take the timbers from step 3 and add the other roof timbers as shown. (Match up the numbers to attach the two parts together). Tap the bolt all the way into the wood to set it. Then add a washer and nut and lightly tighten.

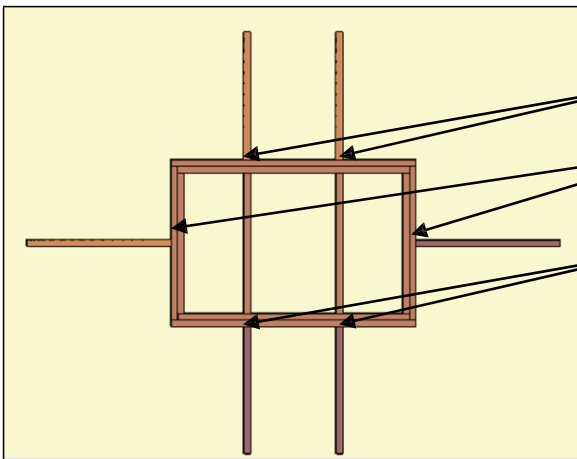

Step 4:

Attach the center rafters to the skylight with 6 bolts (4"x 5/16") washers & nuts. (Match up the numbers to attach the two parts together). Tap the bolt all the way into the wood to set it. Then add a washer and nut and lightly tighten.

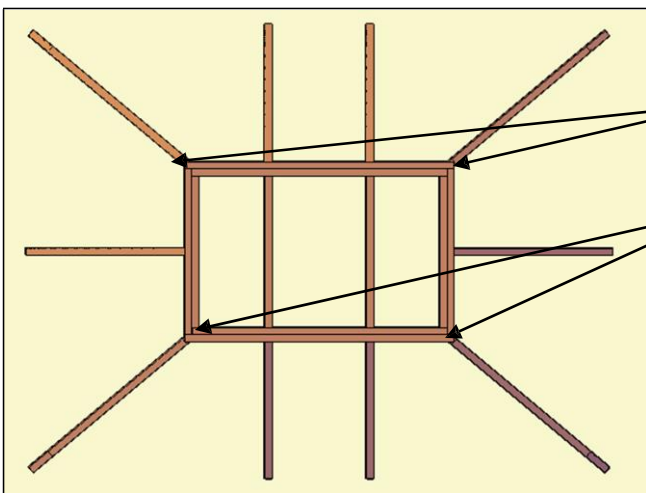

Step 5:

Attach the corner rafters to skylight with 4 bolts (8"x 3/8") washers & nuts. (Match up the numbers to attach the two parts together). Tap the bolt all the way into the wood to set it. Then add a washer and nut and lightly tighten.

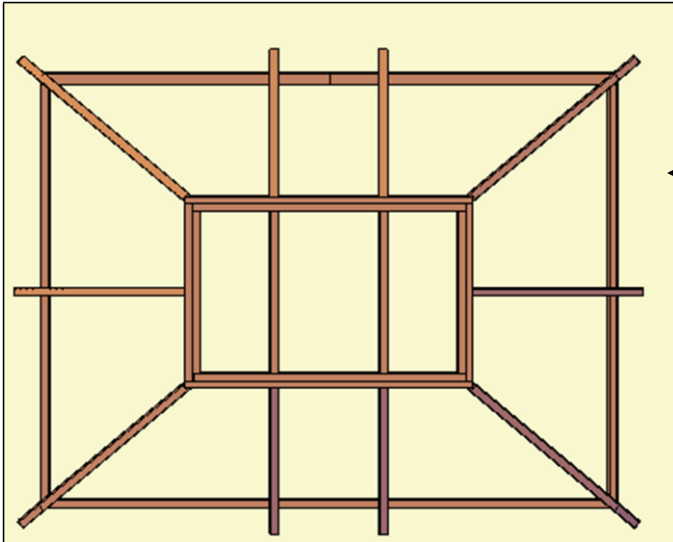

Step 6:

Attach the rafters to base of the roof with 10 bolts (6 ½"x 3/8") washers & nuts. (Match up the numbers to attach the two parts together). Tap the bolt all the way into the wood to set it. Then add a washer and nut and lightly tighten.

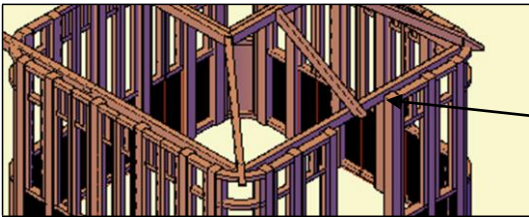

Step 7:

Attach the roof to the top of the Walls with 30 deck screws (3" x 8") – approximately 3 per panel. (Match up the numbers to attach the two parts together).

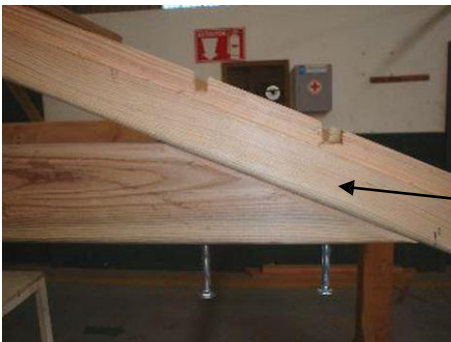

Step 8:

Attach the snow load board to the Rafters with bolts (6 ½" and 4 ½"). Match up the numbers to attach the two parts together.

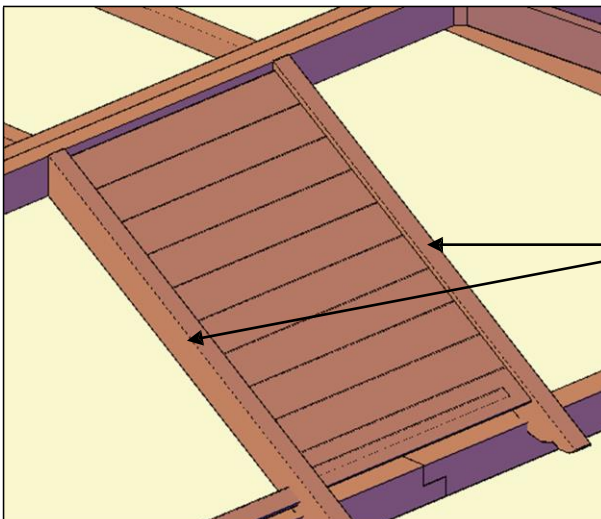

Step 9:

Attach the Roof panel to the rafters with six deck screws (3"x 8"). And repeat the process with each panel roof panel.



Step 10:

Attach the roof trim between each roof panel with three deckscrews (3"x 8"). And repeat the process for each space between the installed roof panels and fill between gaps with silicone.

Step 11:

Attach the doors to the metal hardware installed in the door panels. Use deckscrews (3" x 8").

